

$\varnothing 35$
($\varnothing 34 - \varnothing 37$)

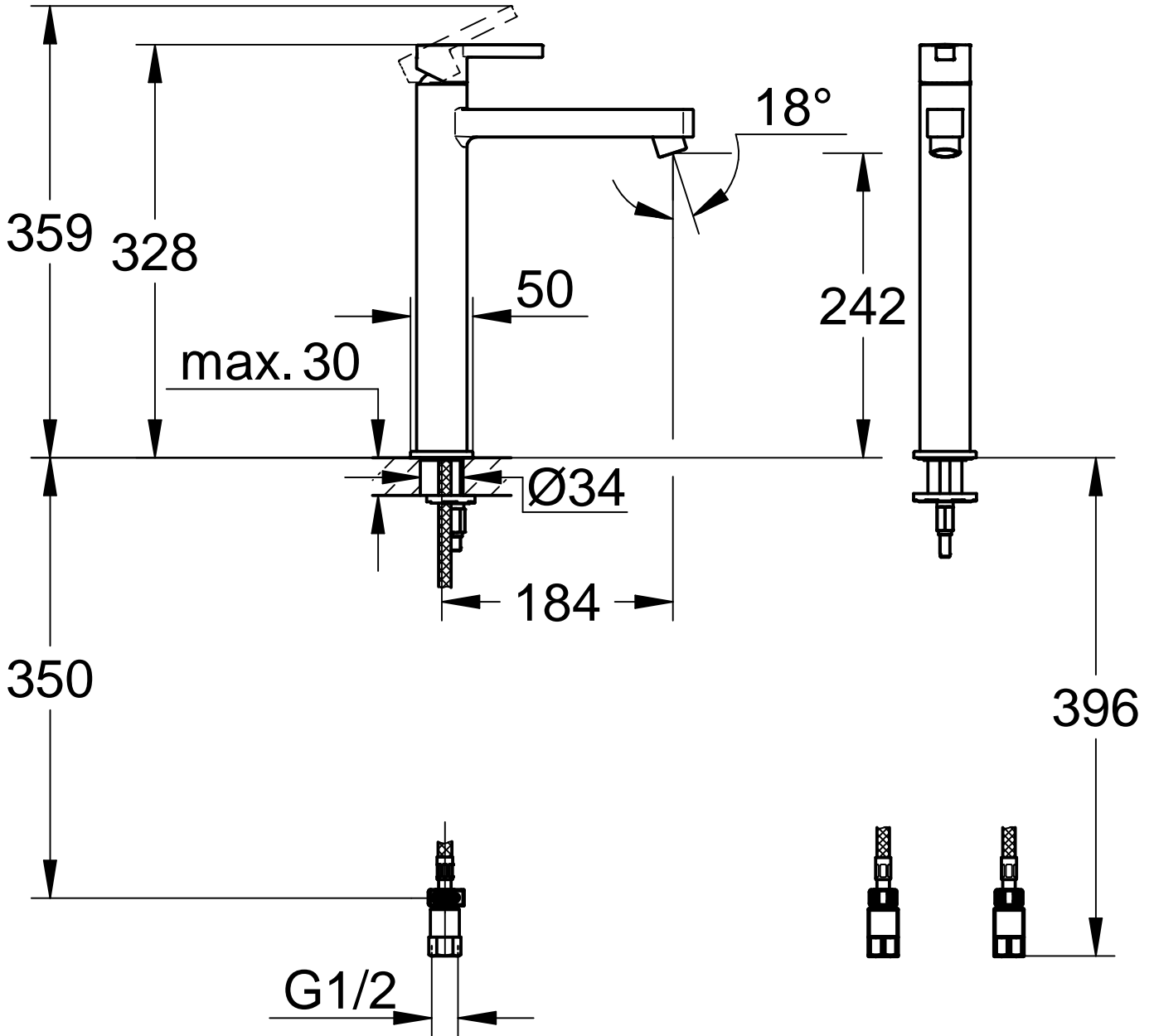
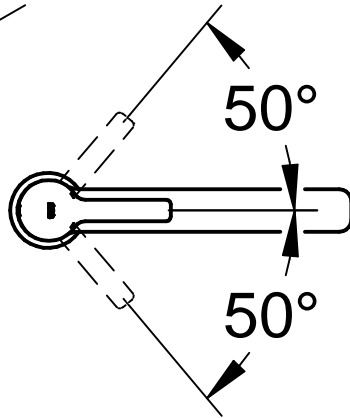

Maßstab / Scale	ÄM-Nr. / ECN				Grohe AG Industriepark Edelburg D-58675 Hemer Tel. 02372 / 93-0	
1:5	Datum / Date	10. 3.2015				
	Verantw. / Respons	Matsumoto		Copyright reserved		
	Geprüft / Approved	Rikukawa				
Status	Benennung / Title	EHM,WT-OHM BASIN			Zeichnung Nr. / Drawing No.: 2340500J	
	Prod.-No. + variants:	2340500J			TPI-Referenz / TPI-Reference: m2340500J 3a	